



eMotio

EXPERT



Updated : March 2019





eMotio is the best examination couch ever designed. Thanks to its sitting position, independent movements and programmable positions, it improves your comfort for daily examinations.

Promotal continuously strives to simplify your daily life. We made this possible through the ability of eMotio to collect your patients vital signs, and directly communicate with the patient electronic medical record while providing a storage solution for instruments. This innovative approach gives you the opportunity to rearrange your exam room to fully focus on diagnosis while saving time and space.



Treatment equality

Tailor your examination for all your patients :

- Access in chair position up to **45cm** from the floor
- Blood pressure **cuffs of all sizes**
- **Several measurement profiles:** monitoring, spot-check and other functions
- The couch accompanies patient movements

Share more with your patients :

- **Share information** with the swivel arm
- Simple and effective information display thanks to **the touch screen**



Efficiency

Streamline your examination with all you need at your fingertips :

- Your preferred examination positions **in 1 click**
- **Integrated** displaying on one screen the blood pressure (NIBP), oximetry, pulse and temperature
- **Storage basket** for your instruments
- **Internal memory** storing 1000 patients and 5000 measurements

Make your diagnosis more reliable and even more precise thanks to :

- The **most precise technologies on the market**
- Wired and **wifi (via accessory)** connectivity with medical record eliminating the need for manual transcription of data
- Self-explanatory user interface with **integrated help function**



Ergonomy

Naturally access the functions needed :

- **Built-in swivel arm monitor** with ergonomic handles for easy patient access
- Recording of 2 **fully configurable** positions
- Your diagnostic instruments **at your fingertips**
- All of your patients' data **in 1 click**



1 Choose your eMotio

Models	Arm rests & leg rests	Adjustable head rest	Tilt
eMotio 4050-20	Accessory	Accessory	Option
eMotio+ 4055-20	●	●	●

Mandatory European plug option **Ref. 40400-1EU**

2 Choose the position of the swivel arm



LEFT
Ref. 40RVS100L

RIGHT
Ref. 40RVS100R

3 Choose your vital signs monitor

PNI + SPO2 Riester + thermometer **Ref. RVS100**

PNI + SPO2 Riester + thermometer + printer **Ref. RVS100PRINT**

4 Select your accessories

For your couch :

- Armrests/legrests 2-in-1 (pair of) **Ref. 40923**
- Pair of stirrups **Ref. 40850**
- Lamp bracket **Ref. 40950**
- Pair of folding assistance handles **Ref. 40922** (incompatible with eMotio +)
- Adjustable headrest **Ref. 11679-01**
- Electrical gynaecological tilt **Ref. 40300** (option)

For your vital signs monitor :

- SpO2 sensor Neonatal **Ref. PR13300**
- SpO2 sensor Child **Ref. PR13301**
- SpO2 sensor Adult **Ref. PR13302**
- Barcode reader **Ref. PR13315**
- Wifi unit **Ref. PR13316**
- Oral / axillary measurement sensor (blue) for Therm. Pred **Ref. PR12669**
- Rectal measuring sensor (red) for Therm. Pred **Ref. PR12668**
- Probe tips for Therm. Pred., Pkg. - 500pc (25x 20 units) **Ref. PR12688**
- Printer paper rolls (x20 pcs) **Ref. PR13321**
- Standard Spo2 extension cable **Ref. PR13309**
- Cuff for adult **Ref. PR107.005**
- Cuff for adult with thin arms **Ref. PR120.002**
- Cuff for large adult **Ref. PR122.005**
- Cuff for children **Ref. PR129.006**
- Cuff for infants **Ref. PR132.003**
- Cuff for neonates **Ref. PR134.002**





Main Features

VITAL SIGNS MONITOR

- > **3 measurement modes** (Monitoring, Spot-check, Sorting)
- > **8 «TFT colour touch screen** with self-explanatory user interface and integrated help function
- > Displays SYS, DIA, MAP, Pulse, Temperature, Plethysmogram
- > **High performance blood pressure monitor** including adult and large adult cuff
- > **SpO2** by Riester
- > Predictive thermometer Filac 3000
- > **Connectivity with electronic medical files*** - according to the HL7 standard
- > **LAN connectivity** as standard
- > **Programmable alarms** (audible, visible) with 3 priority levels
- > **Support for the nurse call** to RJ11 port
- > **Internal memory** for 5.000 measurements

*Depending on your business software, get closer to your sales representative for more information

NIBP measurement

Measurement range	Adult	SYS 30 – 270 mmHg, DIA 10 – 220 mmHg, MAP 20 – 235 mmHg
	Child	SYS 30 – 235 mmHg, DIA 10 – 220 mmHg, MAP 20 – 225 mmHg
	Neonatal	SYS 30-135 mmHg, DIA 10-110 mmHg, MAP 20-125 mmHg
Resolution		1 mmHg
Pressure accuracy	Static	±3 mmHg
	Clinical	±5 mmHg, standard deviation 8 mmHg
Pulse rate		40 – 240 bpm
Pulse accuracy		1 bpm
Pressure range of armband		0 – 280 mmHg

Thermometry

		Temperature measurement	Accuracy (from 35.5°C to 42°C)
Oral (fast mode)	without fever	3-5 seconds	± 0.3°C (±0.5°)
	with fever	8-10 seconds	± 0.3°C (±0.5°)
Oral (standard mode)		6-10 seconds	±0.1°C (±0.2°F)
Axillary mode		8-12 seconds	±0.1°C (±0.2°F)
Rectal mode		10-14 seconds	±0.1°C (±0.2°F)
Direct mode (all sites)		60-120 seconds	±0.1°C (±0.2°F)









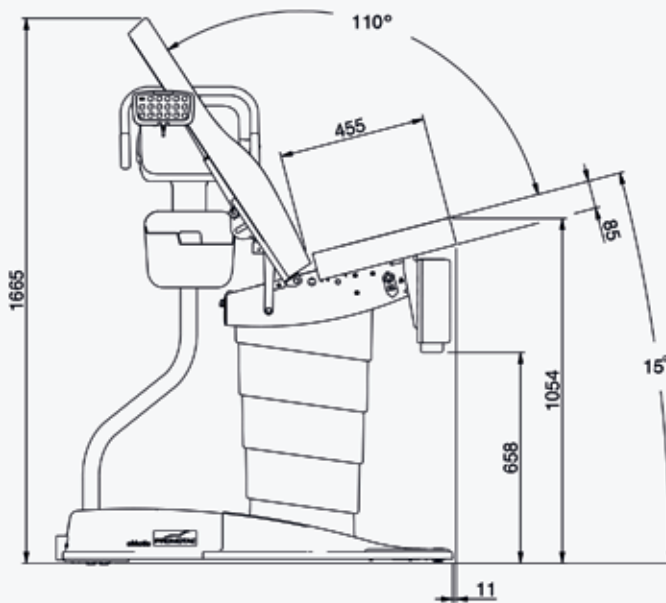
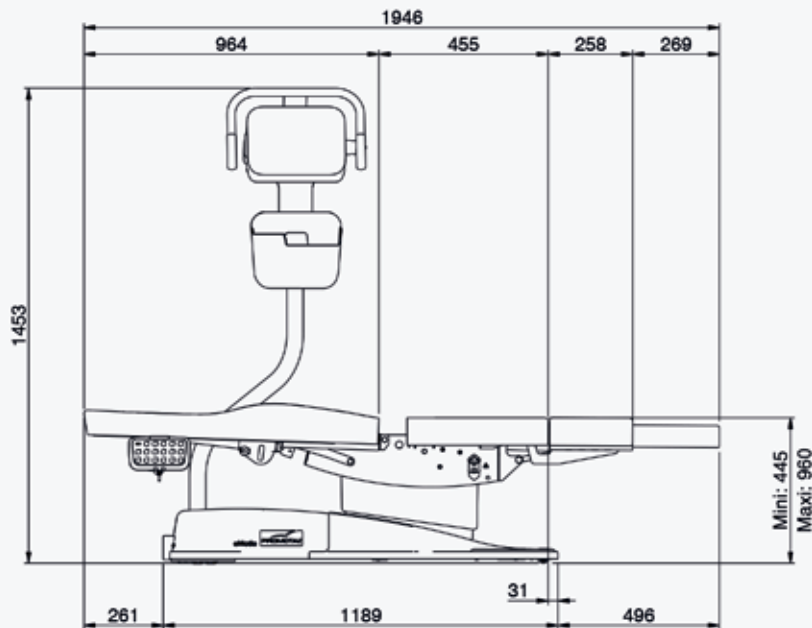









Oximetry

		Riester
SPO2	Measurement range	0 - 100%
	Resolution	1%
	Accuracy	70 - 100%: ±2% 40 - 69%: ±3% 0 - 69%: not specified
	Average time	4 sec, 8 sec, 16 sec
Pouls	Measurement range	20 - 250 bpm
	Resolution	1 bpm
	Accuracy	±1% ou ±1 bpm, the higher of the two



eMotio EXPERT



- | | | |
|-----------------|---|---------|
| 32 - BLUE |  | CLASSIC |
| 93 - COTTAGE |  | |
| 35 - RED |  | |
| 34 - YELLOW |  | |
| 91 - WHITE |  | |
| 92 - MARINE |  | VITAMIN |
| 56 - DARKNESS |  | |
| 57 - ANTISTATIC |  | |
| 64 - GRAPE |  | |
| 67 - LAGOON |  | |
| 66 - SWEET |  | COSY |
| 63 - CEDRAT |  | |
| 80 - SKY |  | |
| 81 - SEA GREEN |  | |
| 65 - LILAC |  | |
| 96 - TIN |  | |
| 82 - MOUSE GREY |  | |
| 83 - NATURAL |  | |
| 84 - CHOCOLATE |  | |



PROMOTAL.COM



22 rue de Saint-Denis-de-Gastines - 53500 Ernée, FRANCE

Phone : + 33 (0)2 43 05 68 95

Fax : + 33 (0)2 43 05 72 00